

Instruction Manual

*G.R.A.S 41AC-3 CCP Outdoor Microphone
for Community & Airport Noise*



Revision History

Any feedback or questions about this document are welcome at gras@gras.dk.

Revision	Date	Description
1	26 August 2014	First edition
2	4 July 2017	42AG substituted for the obsolete 42AB

Copyright Notice

© 2014, 2017 G.R.A.S. Sound & Vibration A/S

<http://www.gras.dk>

Any technical documentation that is made available by G.R.A.S. is the copyrighted work of G.R.A.S. and is owned by G.R.A.S.

The content in this document is subject to change without notice. G.R.A.S. Sound & Vibration A/S is not liable or responsible for any errors or inaccuracies that may appear in this document.

Trademarks

Any product names mentioned in this document may be trademarks or registered trademarks of their respective companies and are hereby acknowledged.

Contents

Introduction.....	4
Delivered Items.....	4
Installation	6
System Integration	12
Accessories	14
Specifications	14
Calibration, Warranty and Service	18

Introduction

The G.R.A.S. 41AC-3 CCP Outdoor Microphone for Community & Airport Noise is a precision microphone set (IEC 61672-1) for monitoring community noise and the noise of overhead aircraft.

It can be used for monitoring of noise with 90 degrees of incidence, typically community noise. With the proper correction data, it can be used for 0 degrees of incidence, typically noise from overhead aircraft. A USB flash drive with correction data is part of the delivery.

It is waterproof, rated at IP-55, and can operate unattended over a wide range of weather conditions and temperatures for a very long period, i.e. a year or longer.

It uses a G.R.A.S. 40AE-S2 1/2" Prepolarized Free-field Microphone, High Sensitivity and a G.R.A.S. 26CA 1/2" CCP Standard Preamplifier with BNC Connector.

It has TEDS according to IEEE1451.4 template UDID 127-0-0-OU.

Important. The 40AE-S2 microphone and its protective grid have been modified for the 41AC-3. Therefore, microphone and grid cannot be replaced by standard items.

Delivered Items

1/2" Prepolarized Free-Field Microphone, High Sensitivity	40AE-S2
1/2" CCP Standard Preamplifier with BNC Connector	26CA
O-ring for preamplifier	OR2038
USB flash drive with correction data for 0° (resolution: 1/12 octave)	
Wind Screen	AM0378
Top cone	-
Upper housing	-
Lower housing	-
1" pole mount adapter	RA0286
Tripod Adapter	GR1096
Tripod thread adapter	SK0017

41AC-3 is delivered preassembled except for the windscreen and thread adapter.

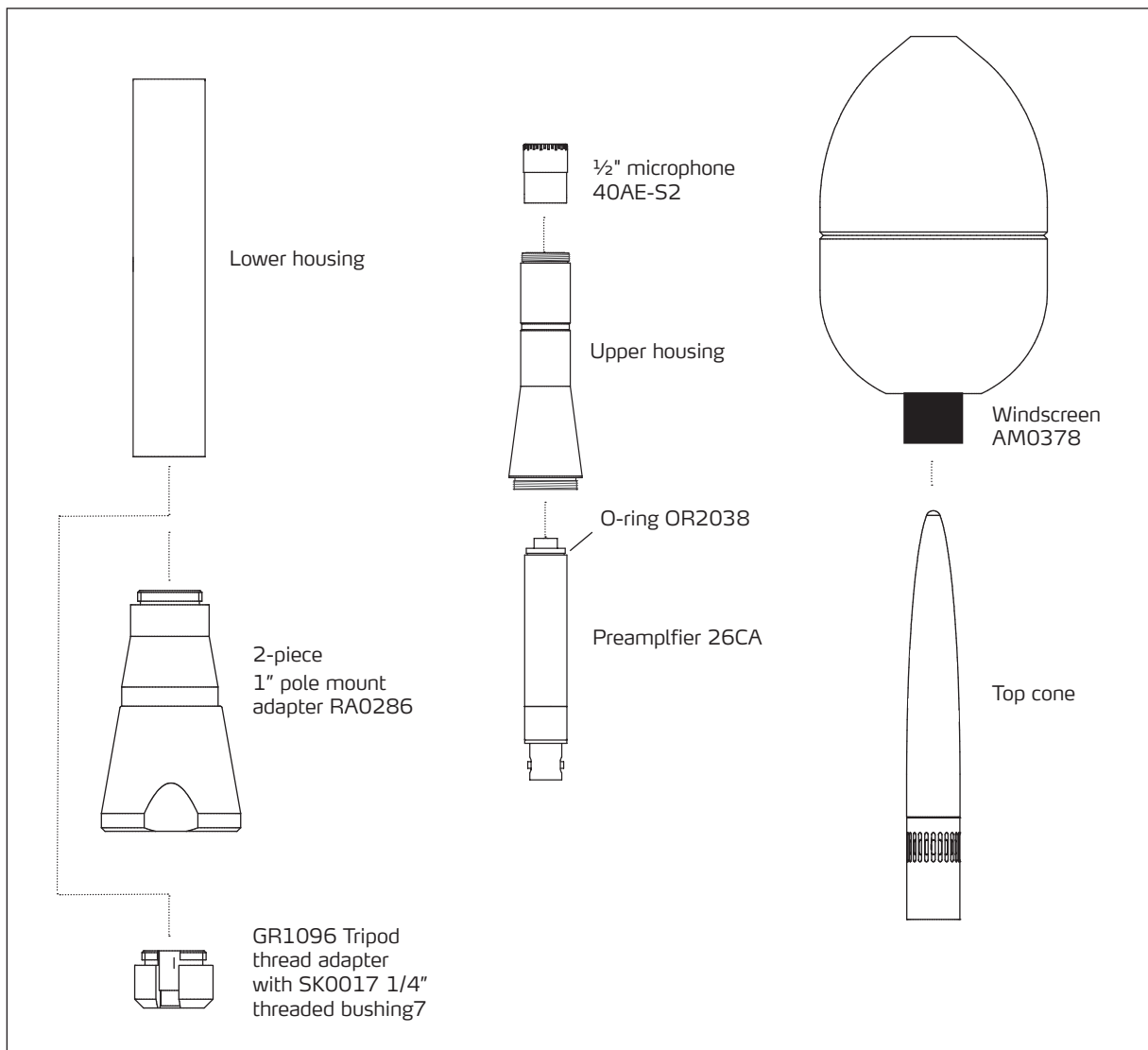

Fig. 1. The parts of 42AC-3.

Installation

Mounting 41AC-3 on Tripod or Pole Mount Adapter

The 41AC-3 is designed for permanent installation and therefore comes with an adapter for mounting on a 1" pole. See Fig. 2 and Fig. 3, 3. The 41AC-3's housing is attached to the mounting fittings with a M18 x 1.5 thread.

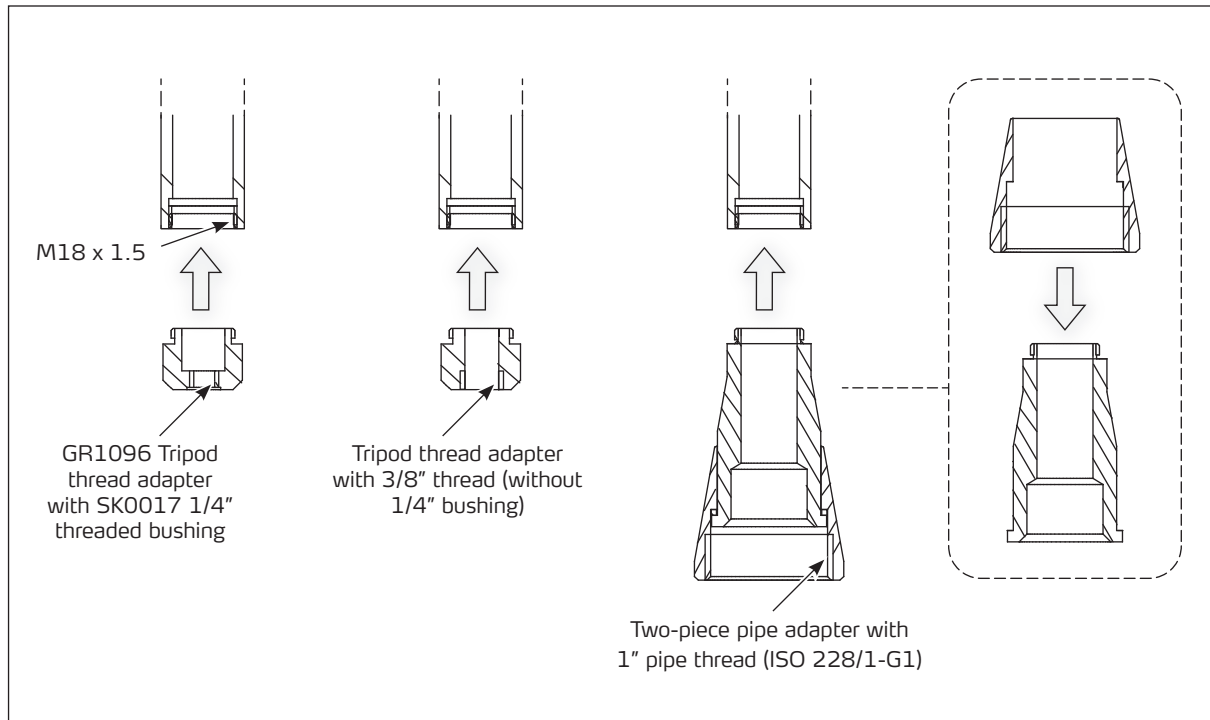

Fig. 2. The 41AC-3 lower housing's thread and adaptor for tripod or pole mount.

Removing the Preamplifier

As delivered, the microphone set is mounted inside the housing. To attach the cable, you must remove the top, remove the microphone and pull out the preamplifier.

1. Unscrew the top cone from the housing.
2. Set it aside and ensure that it is protected from dirt and moisture.
3. Remove the microphone from the preamplifier and set it aside. Ensure that it is protected from dirt and moisture.
4. Push at the top of the preamplifier to make it slide down through the tube.

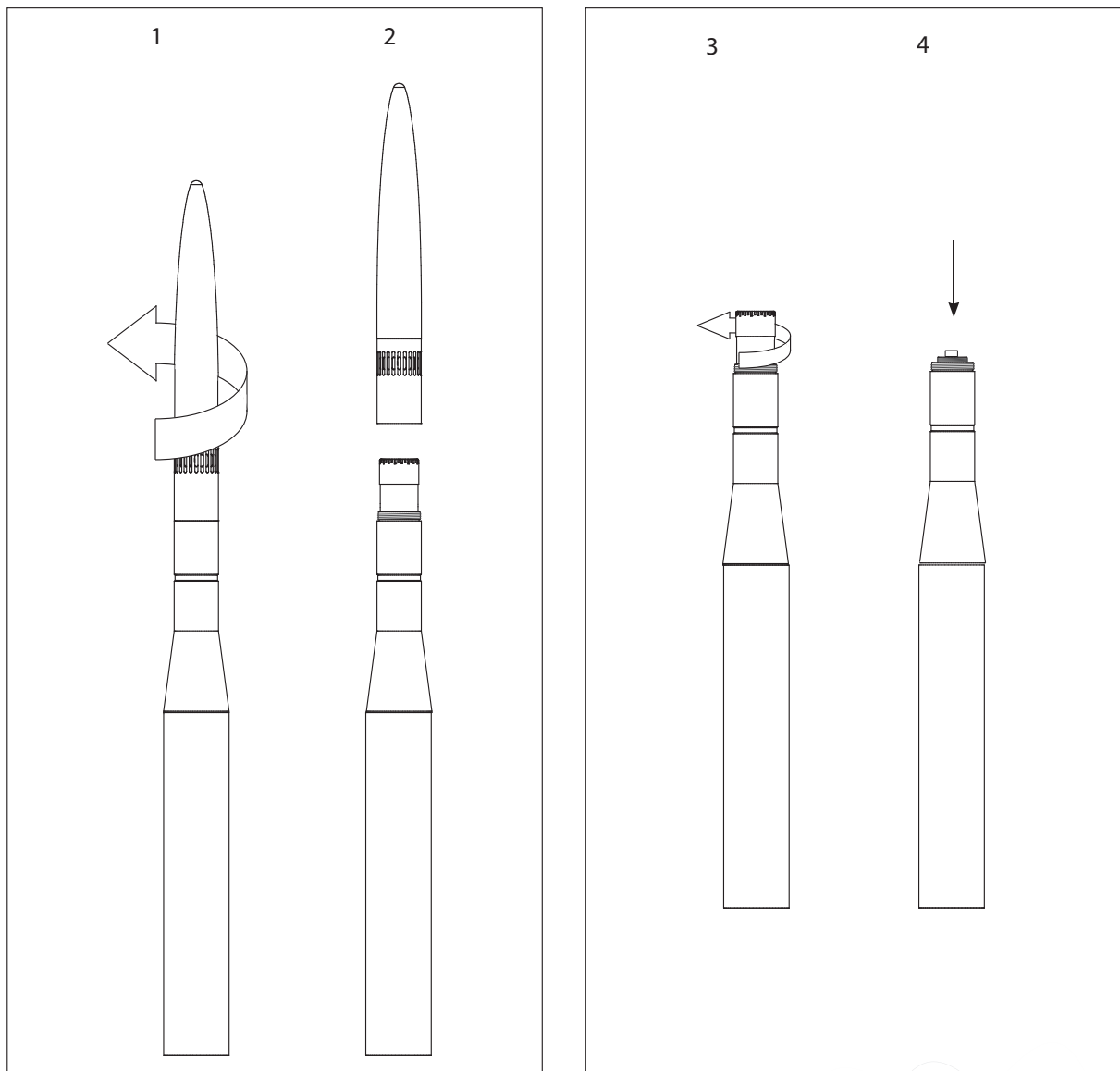

Fig. 3. Removing the top cone and releasing the preamplifier.

Connecting the Cable to the Preamplifier and Remounting the Microphone Set

1. Connect the cable to the preamplifier.
2. Push the preamplifier up through the lower and upper housing.
3. To expose the thread for the microphone, ensure that the preamplifier is pushed up as far as it will go.
4. Mount the microphone onto the preamplifier and tighten lightly.

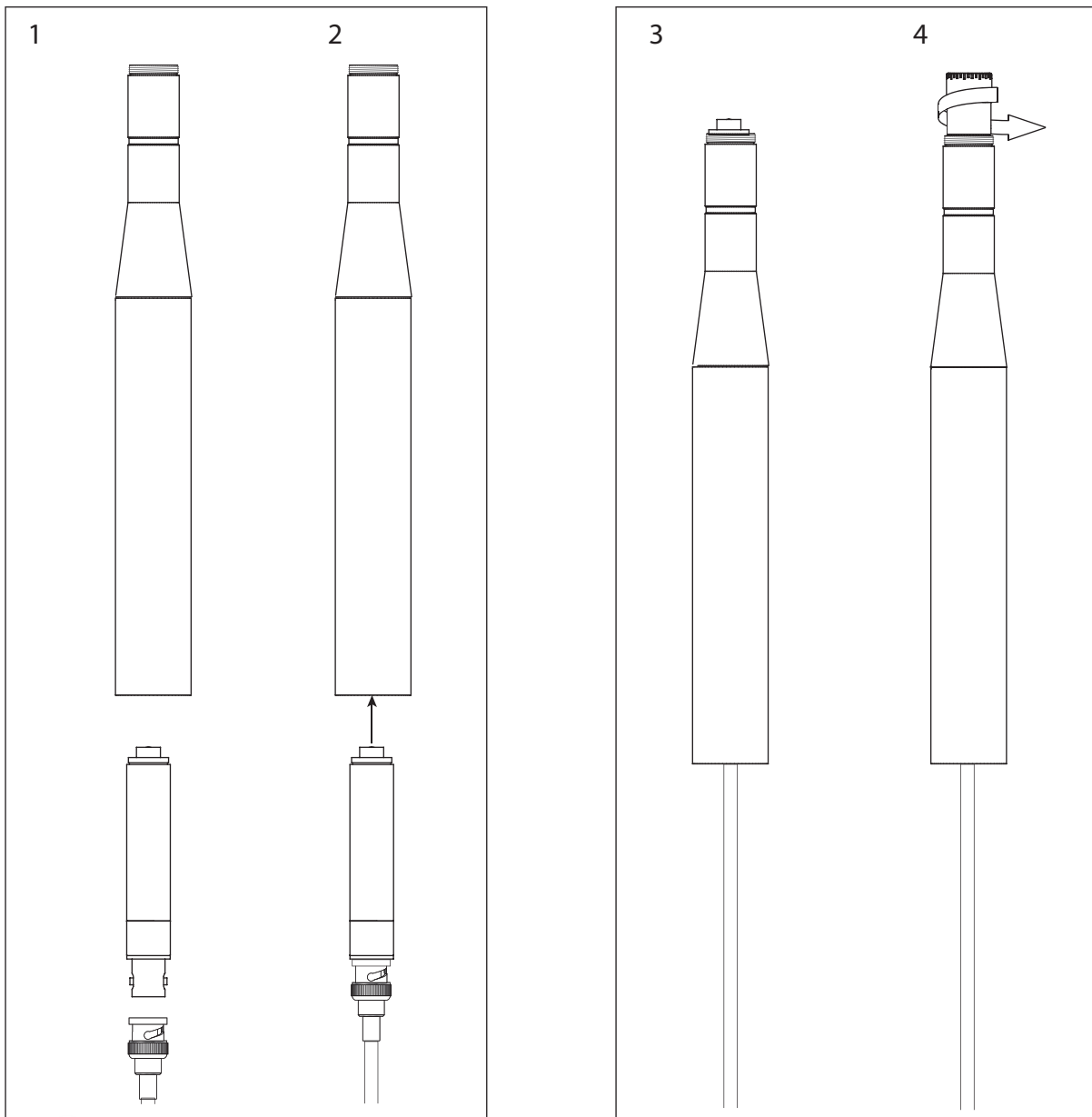

Fig. 4. Connecting the cable and securing the microphone set.

Mounting the Top Cone

When the microphone has been mounted on the preamplifier, you can mount the top cone.

1. Screw on the top cone.
2. Ensure that the top cone is properly fastened.

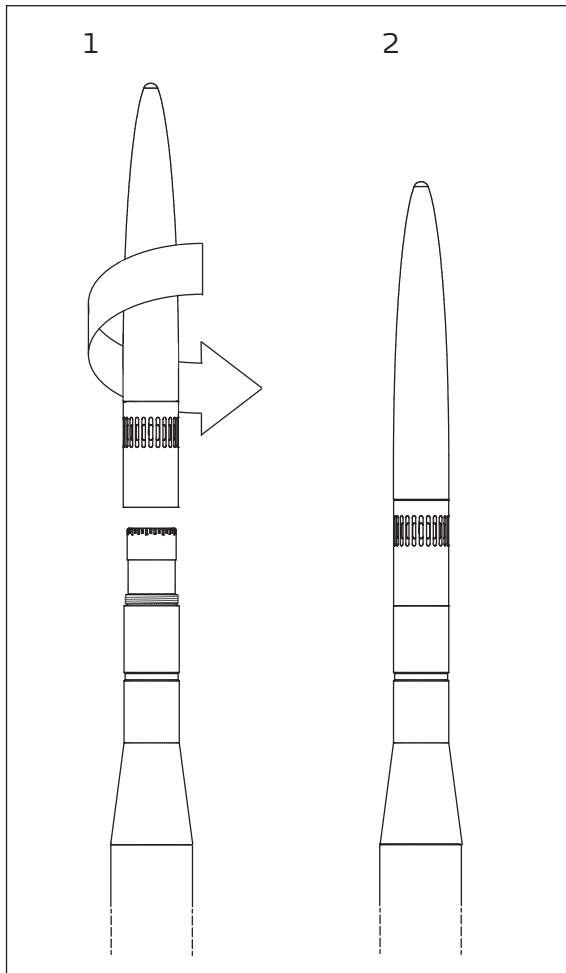

Fig. 5. Mounting the upper housing and the top cone.

Mounting the Windscreen

The windscreen is glued onto a plastic tube that ensures that it can be positioned correctly:

- When pushed down, the windscreen tube is prevented from going too far by the upper housing's conical shape.
- When the windscreen is pushed as far down as it will go, it will be kept in place by a locking groove. Because of this, it cannot be dislocated unintentionally, and incorrect measurements due to an incorrectly positioned windscreen are avoided.

1. Slide the tube down over the top cone.
2. Ensure that the tube is pushed as far down as it will go.

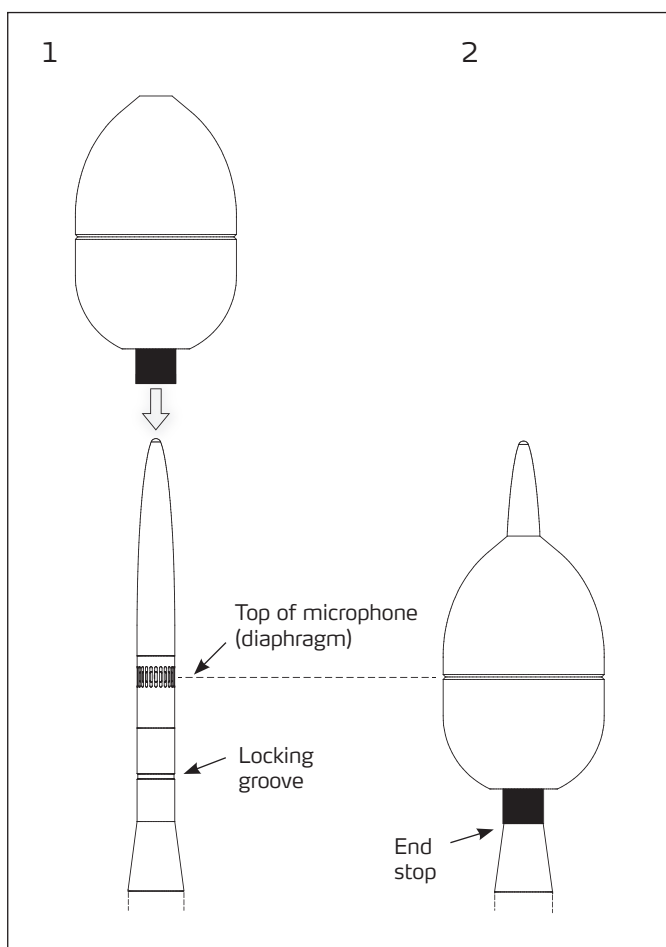

Fig. 6. Mounting the wind screen.

Disassembly

You can disassemble the 41AC-3 by reversing the procedure described on the preceding pages.

The windscreen tube is held in place by a locking mechanism. Therefore, some force must be applied to slide the tube back up.

1. Push at the end of the windscreen tube with a finger nail or a piece of hard plastic.

Caution. Do NOT pull at the foam as this could cause it to deform or loosen it from the tube.

2. Unscrew the top cone.
3. Unscrew the microphone.
4. Slide the preamplifier downwards and disconnect the cable.

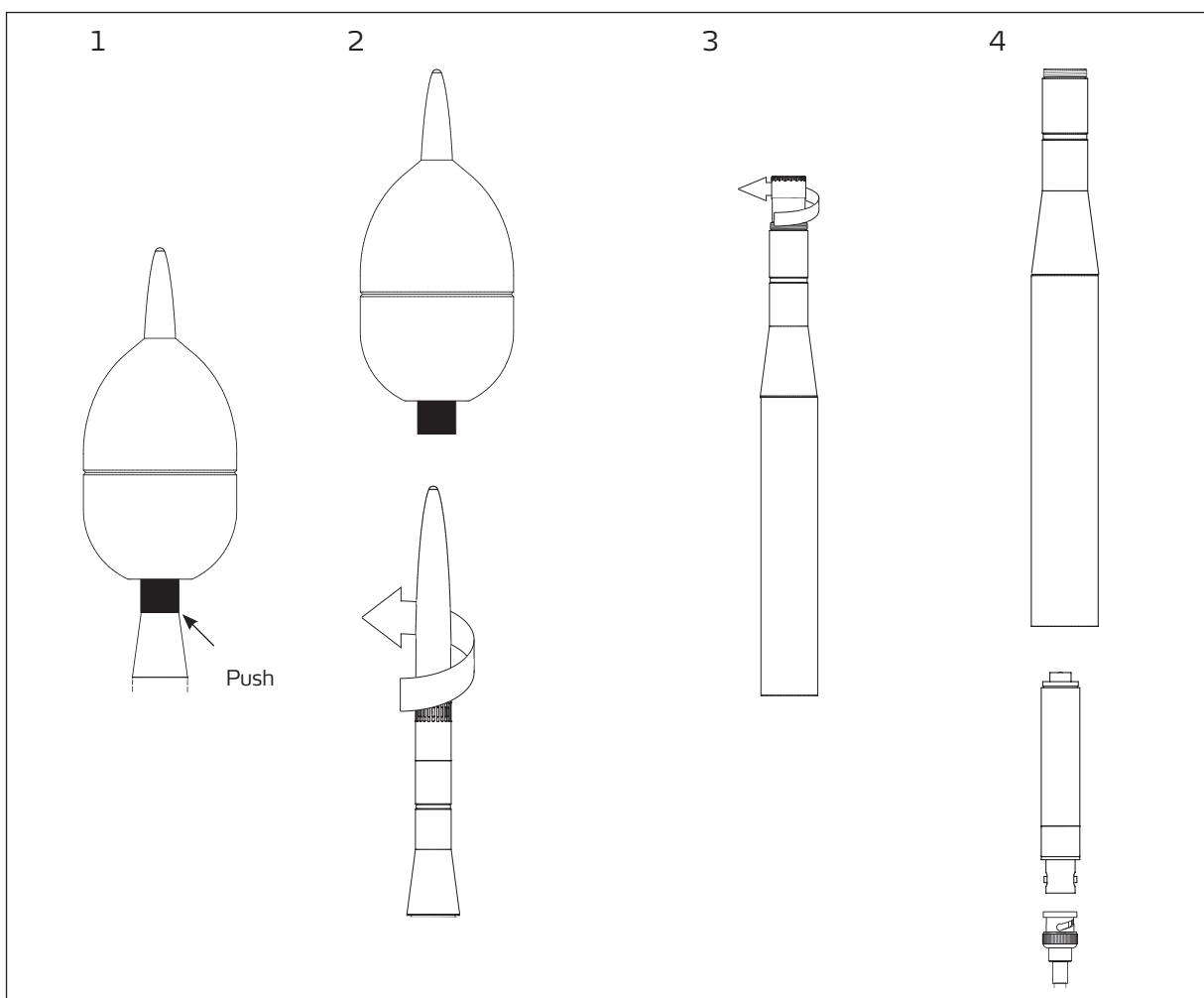

Fig. 7. Removing the wind screen and disconnecting the cable.

System Integration

TEDS

41AC-3 has TEDS according to IEEE1451.4 template UDID 127-0-0-0U.

Setting the 41AC-3 for 90 or 0 Degrees of Incidence

The 41AC-3 is designed to be mounted vertically, as described in the previous sections. Mounted in this way, it can be set up for measurement at either 90 degrees or 0 degrees of incidence.

The correction data contained on the USB flash drive that is part of the delivery must be used if the 41AC-3 is used for 0 degrees of incidence. The correction data are measured with a resolution of 1/12 octave.

Polarization Voltage = 0 V

41AC-3 uses a prepolarized microphone with a 26CA 1/2" CCP Preamplifier and must be connected to a CCP input of an analyzer.

Distance to the Ground

When mounted on a pipe or tripod, the distance from the bottom of the microphone to the ground reflecting surface must be at least 20 cm/7.9" to minimize the influence of ground reflections on the sound field.

Replacing Microphone and/or its Protective Grid

The 40AE-S2 microphone and its protective grid are designed specifically for the 41AC-3. Only the 40AE-S2 will ensure the stated measurement results and water protection. Therefore neither microphone nor its protective grid can be replaced with standard items.

Verification and Calibration

An acoustic in-situ verification or a calibration in a laboratory with a pistonphone or a sound calibrator requires that windscreen and top cone are dismantled. How to do this is shown in Fig. 7. Calibration can be performed using a Sound Calibrator or a Pistonphone. The G.R.A.S. 42AP Intelligent Pistonphone is recommended because of its built-in thermometer and barometer. The Sound Calibrator/Pistonphone must be fitted with a coupler for 1/2-inch microphones.

Refer to the manual for your sound calibrator or pistonphone for further information.

Maintenance

Depending on local conditions, the windscreen must be cleaned or replaced. How often must be determined by visual inspection and knowledge of local weather conditions.

O-ring OR2038 (see page 5) must be lubricated with silicon grease at regular intervals. Without lubrication it must be replaced once a year.

When under power, the preamplifier emits heat. This heat is part of the 41AC's protection against moisture, and therefore the power to the 41AC should be turned on permanently.

Accessories

Intelligent Pistonphone	42AP
Pistonphone	42AA
Multifunction Sound Calibrator	42AG
3 m BNC - BNC Cable	AA0035
10 m BNC - BNC Cable	AA0037
30 m BNC - BNC Cable	AA0038
Customized length BNC - BNC Cable	AA0039-CLXXXX

Specifications

Dynamic range lower limit (microphone thermal noise)	17 dB(A)
Dynamic range upper limit	138 dB
Set sensitivity @ 250 Hz (± 2 dB)	50 mV/Pa
Compliance	IEC 61672-1
Polarization voltage	0 V
Power supply	2 - 20 mA
Temperature range, operation	-30 to 70 / -22 to 158
Connector type	BNC
TEDS	IEEE1451.4 template UDID 127-0-0-0U
CE/RoHS compliant/WEEE registered	Yes/Yes/Yes
Water Resistance	IP55

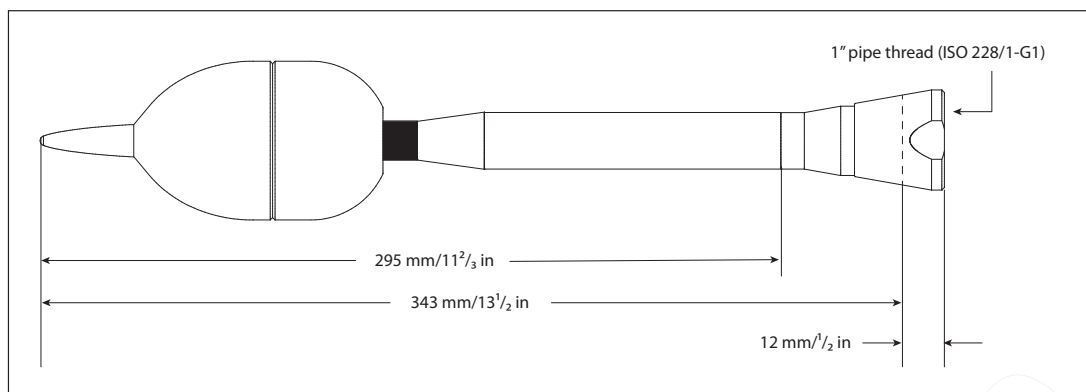

Fig. 8. When mounted on a pipe, the top of the 41AC will be elevated 343 mm above the pipe.

Frequency Response and Directional Response

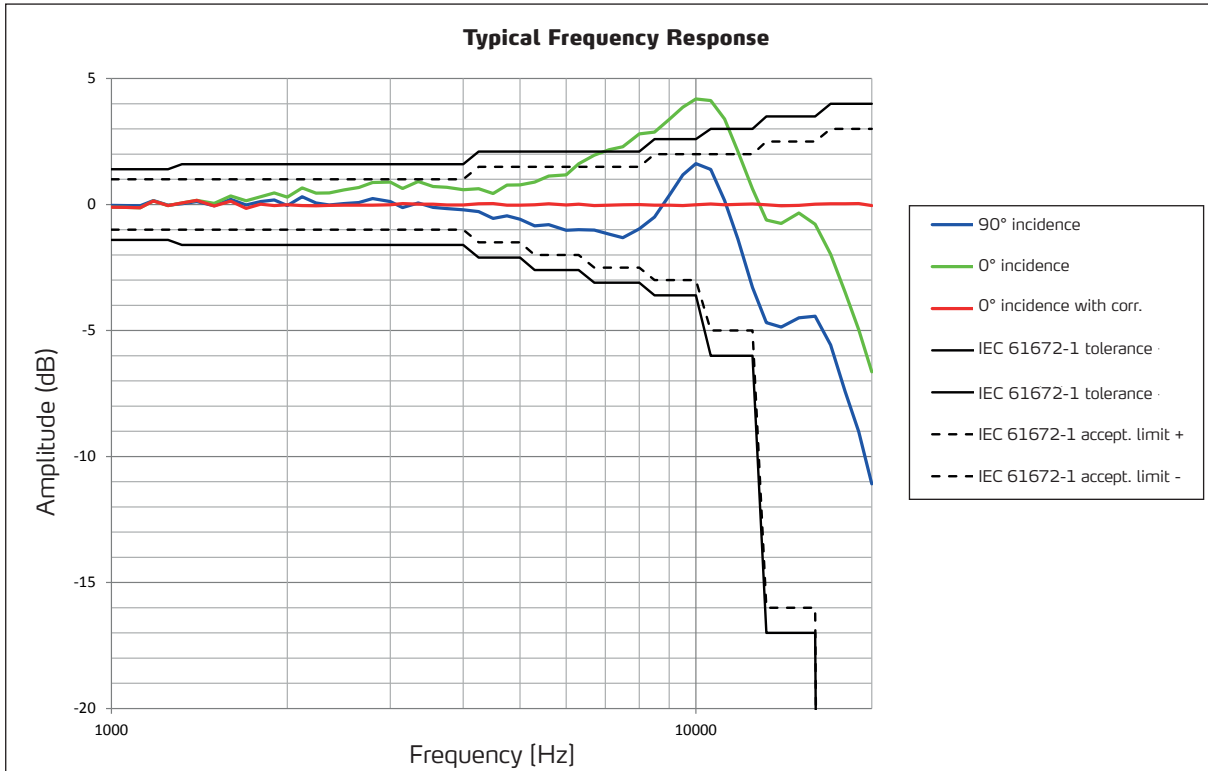

Fig. 9. Typical frequency response.

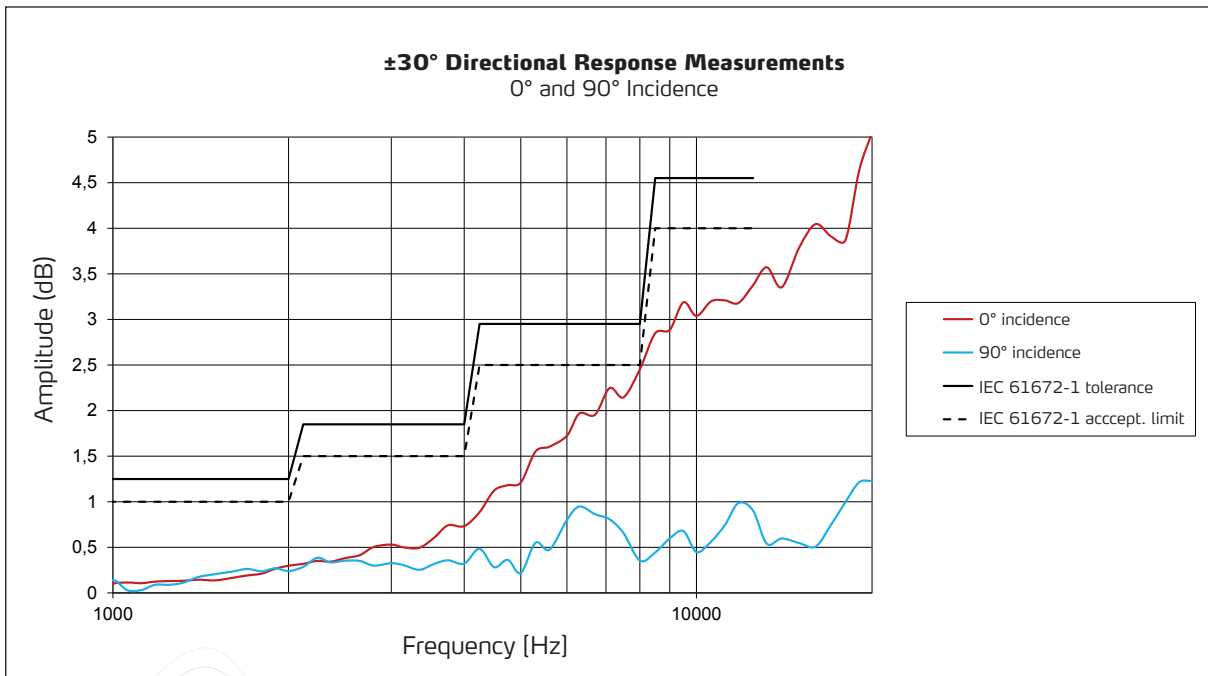

Fig. 10. ±30° directional response at 0° and 90° incidence.

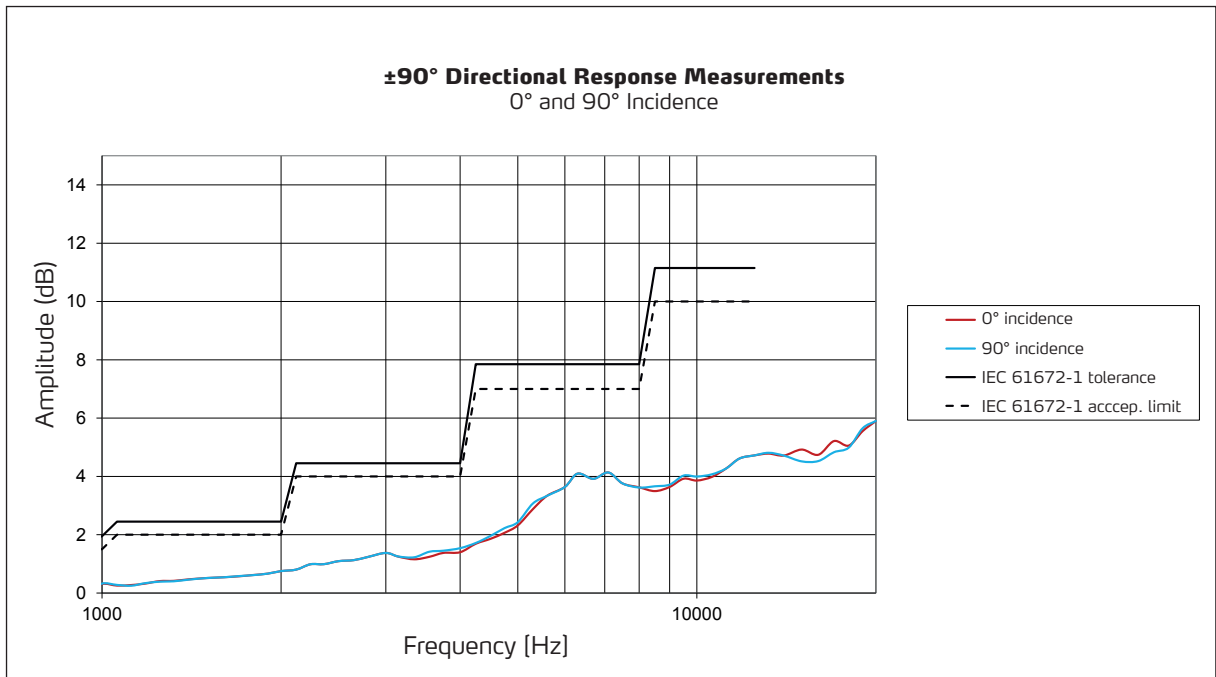

Fig. 11. ±90° directional response at 0° and 90° incidence.

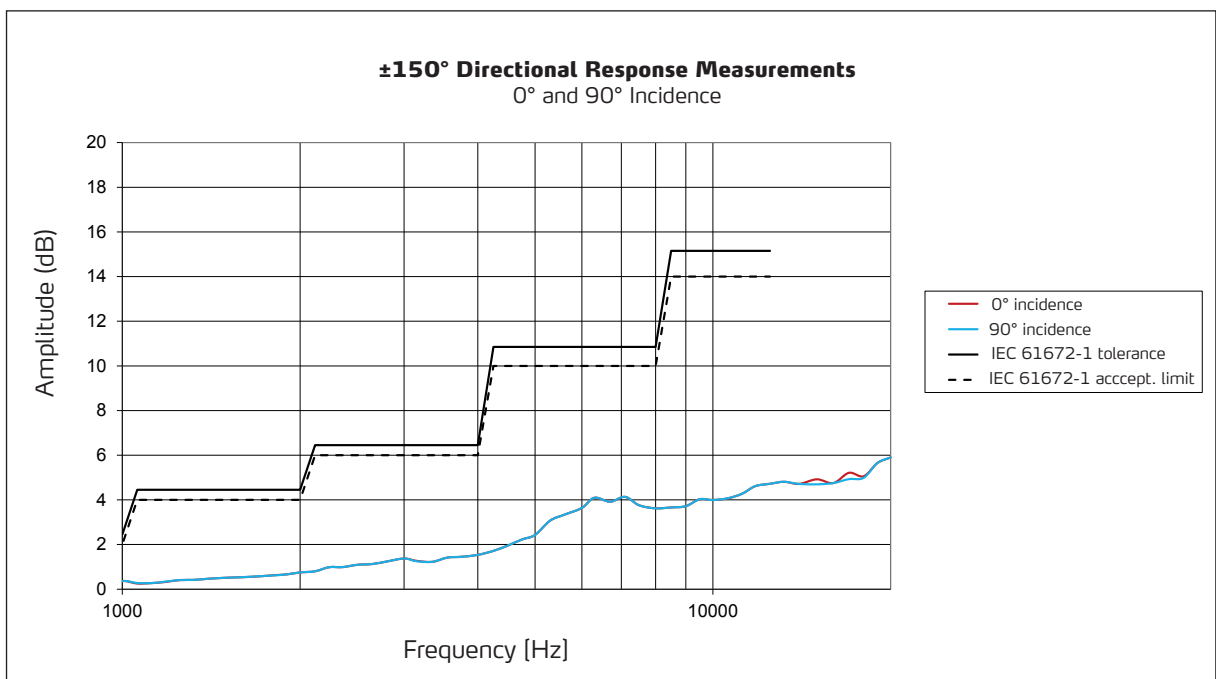

Fig. 12. ±150° directional response at 0° and 90° incidence.

Calibration, Warranty and Service

Calibration

Before leaving the factory, all G.R.A.S. products are calibrated in a controlled laboratory environment using traceable calibration equipment.

An individual test certificate stating the sensitivity and frequency response is included with each product.

Warranty

All G.R.A.S. products are made of high-quality materials that will ensure life-long stability and robustness. The 41AC-3 is delivered with a 5-year warranty.

The windscreen comes with a 6-month warranty, this warranty covers defective workmanship only and not the effects of normal use.

Damaged diaphragms in microphones can be replaced.

The warranty does not cover products that are damaged due to negligent use, an incorrect power supply, or an incorrect connection to the equipment.

Service and Repairs

All repairs are made at G.R.A.S. International Support Center located in Denmark. Our Support Center is equipped with the newest test equipment and staffed with dedicated and highly skilled engineers. Upon request, we make cost estimates based on fixed repair categories. If a product covered by warranty is sent for service, it is repaired free of charge, unless the damage is the result of negligent use or other violations of the warranty. All repairs are delivered with a service report, as well as an updated calibration chart.

Manufactured to conform with:

CE marking directive:
93/68/EEC



WEEE directive:
2002/96/EC



RoHS directive:
2002/95/EC



G.R.A.S. Sound & Vibration continually strives to improve the quality of our products for our customers; therefore, the specifications and accessories are subject to change without notice.